

# STANLEY BOSTITCH

Model **N12B** Series  
COIL-FED PNEUMATIC NAILERS



## OPERATION and MAINTENANCE MANUAL

**▲ WARNING:**

BEFORE OPERATING THIS TOOL, ALL OPERATORS SHOULD STUDY THIS MANUAL, TO UNDERSTAND AND FOLLOW THE SAFETY WARNINGS AND INSTRUCTIONS. KEEP THESE INSTRUCTIONS WITH THE TOOL FOR FUTURE REFERENCE. IF YOU HAVE ANY QUESTIONS, CONTACT YOUR STANLEY-BOSTITCH REPRESENTATIVE OR DISTRIBUTOR.

**STANLEY BOSTITCH**

Stanley Fastening Systems

BSA1474S REV T 1/93

## INTRODUCTION

The Stanley-Bostitch N12 series nailers are precision built-tools, designed for high speed, high volume nailing. These coil-fed nailers will deliver efficient, dependable service when used correctly and with care. As with any fine power tool, for best performance the manufacturer's instructions must be followed. Please study this manual before operating the nailer and understand the safety warnings and cautions. The instructions on installation, operation and maintenance should be read carefully and the manual kept for reference. **NOTE:** Additional safety measures may be required because of your particular application. Contact your Stanley-Bostitch representative or distributor with any questions concerning the nailer and its use.

## INDEX

Safety Instructions .....	3
Tool Specifications .....	4
Air Supply .....	5
Fittings	
Hoses	
Filters	
Air Consumption	
Regulators	
Operating Pressure	
Setting Correct Pressure	
Lubrication .....	5
Loading the Tool .....	6
Shingle Gauge Adjustment .....	6
Operating the Tool .....	7,8
Basic Tool Operation .....	9
Maintaining the Tool .....	9
Trouble Shooting .....	10
Cleaning the Roofing Nailer .....	11
Exploded View / Parts List - Body .....	12
Exploded View / Parts List - Magazine .....	13
Tool Maintenance / Service Record .....	14
Accessories .....	15
Limited Warranty .....	Back Cover

**NOTE:** Stanley-Bostitch tools have been engineered to provide excellent customer satisfaction and are designed to achieve maximum performance when used with precision Stanley-Bostitch fasteners engineered to the same exacting standards. **Stanley-Bostitch cannot assume responsibility for product performance if our tools are used with fasteners or accessories not meeting the specific requirements established for genuine Stanley-Bostitch nails, staples, and accessories.**



## SAFETY INSTRUCTIONS

**▲ WARNING:**

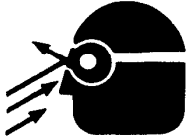

**EYE PROTECTION** which conforms to ANSI specifications and provides protection against flying particles both from the **FRONT** and **SIDE** should **ALWAYS** be worn by the operator and others in the work area when loading, operating or servicing this tool. Eye protection is required to guard against flying fasteners and debris, which could cause severe eye injury.

The employer and/or user must ensure that proper eye protection is worn. Eye protection equipment must conform to the requirements of the American National Standards Institute, ANSI Z87.1-1979 and provide both frontal and side protection. **NOTE:** Non-side shielded spectacles and face shields alone do not provide adequate protection.

**CAUTION:**



**EAR PROTECTION** may be required in some environments. As the working area may include exposure to high noise levels which can lead to hearing damage, the employer and user should ensure that any necessary hearing protection is provided and used by the operator and others in the work area.

## AIR SUPPLY AND CONNECTIONS

**▲ WARNING:**

Do not use oxygen, combustible gases, or bottled gases as a power source for this tool as tool may explode, possibly causing injury.

**▲ WARNING:**

Do not use supply sources which can potentially exceed 200 P.S.I.G. as tool may burst, possibly causing injury.

**▲ WARNING:**

The connector on the tool must not hold pressure when air supply is disconnected. If a wrong fitting is used, the tool can remain charged with air after disconnecting and thus will be able to drive a fastener even after the air line is disconnected, possibly causing injury.

**▲ WARNING:**

Do not pull the trigger or depress the contact trip while connecting the tool to the air supply as the tool may cycle, possibly causing injury.

**▲ WARNING:**

Always disconnect air supply: 1.) Before making adjustments; 2.) When servicing the tool; 3.) When clearing a jam; 4.) When tool is not in use; 5.) When moving to a different work area, as accidental actuation may occur, possibly causing injury.

## LOADING TOOL

**▲ WARNING:**

When loading tool: 1.) Never place a hand or any part of body in fastener discharge area of tool; 2.) Never point tool at anyone; 3.) Do not pull the trigger or depress the trip as accidental actuation may occur, possibly causing injury.

## OPERATION

**▲ WARNING:**

Always handle the tool with care: 1.) Never engage in horseplay; 2.) Never pull the trigger unless nose is directed toward the work; 3.) Keep other persons a safe distance from the tool while tool is in operation as accidental actuation may occur, possibly causing injury.

**▲ WARNING:**

The operator must not hold the trigger pulled on contact trip tools except during fastening operation as serious injury could result if the trip accidentally contacted someone or something, causing the tool to cycle.

**▲ WARNING:**

Keep hands and body away from the discharge area of the tool. A contact trip tool may bounce from the recoil of driving a fastener and an unwanted second fastener may be driven, possibly causing injury.

**▲ WARNING:**

Check operation of the contact trip mechanism frequently. Do not use the tool if the trip is not working correctly as accidental driving of a fastener may result. Do not interfere with the proper operation of the contact trip mechanism.

**▲ WARNING:**

Do not drive fasteners on top of other fasteners as this may cause deflection of fasteners which could cause injury.

## MAINTAINING THE TOOL

**▲ WARNING:**

When working on air tools note the warnings in this manual and use extra care when evaluating problem tools.

## N12B FEATURES

- Choice of contact or sequential trip operation.
- The magazine accomodates 7/8"-1-3/4" nails with a simple twist.
- Fast, easy reloading—120 nails in each coil.
- Adjustable gauge for quick, accurate shingle placement.
- Wide contact trip with carbide inserts resist granule abrasion.
- Operates over a wide range of air pressures 70-100 P.S.I.G.
- Light alloy frame for ease of handling and good balance.
- Nail magazine and driving channel open completely for fast, easy reloading or cleaning of tool.

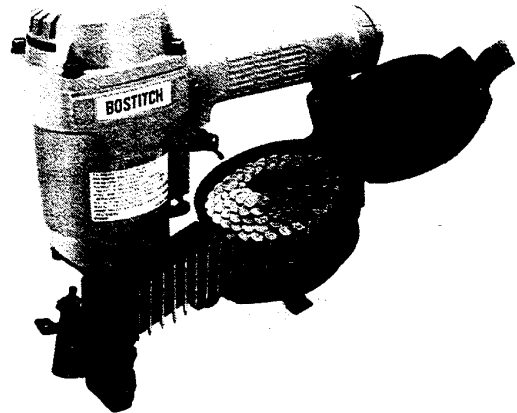

### TOOL SPECIFICATIONS

All screws and nuts are metric.

MODEL	TOOL OPERATION	LENGTH	HEIGHT	WIDTH	WEIGHT	NAIL SPECIFICATIONS	
						Nail No.	Length
N12B-1	Contact Trip	10-5/8" (270mm)	10" (250mm)	4-3/8" (112mm)	6 lbs.(2.7 kg)	CR2DCGAL	7/8"
						CR2DGAL	1"
N12B-1ST	Sequential Trip	10-5/8" (270mm)	10" (250mm)	4-3/8" (112mm)	6 lbs.(2.7 kg)	CR3DGAL	1-1/4"
						CR4DGAL	1-1/2"
						CR5DGAL	1-3/4"

#### TOOL AIR FITTING:

This tool uses a 1/4 N.P.T. male plug. The inside diameter should be .200" (5mm) or larger. The fitting must be capable of discharging tool air pressure when disconnected from the air supply.

#### OPERATING PRESSURE:

70 to 100 p.s.i.g. (4.9 to 7.0 kg/cm<sup>2</sup>). Select the operating pressure within this range for best fastener performance. **DO NOT EXCEED THIS RECOMMENDED OPERATING PRESSURE.**

#### AIR CONSUMPTION:

Model N12B require 3.8 cubic feet per minute (c.f.m.) of free air to operate at the rate of 100 nails per minute, at 80 p.s.i.g. Take the actual rate at which the tool will be run to determine the amount of air required. For instance, if your nail usage average is 50 nails per minute, you need 50% of the 3.8 c.f.m. which is required for running at 100 nails per minute.

### STANLEY-BOSTITCH OFFERS TWO TYPES OF OPERATION FOR THIS SERIES TOOL

#### CONTACT TRIP

The common operating procedure on "Contact Trip" tools is for the operator to contact the work to actuate the trip mechanism while keeping the trigger pulled, thus driving a fastener each time the work is contacted. This will allow rapid fastener placement on many jobs, such as sheathing, decking and pallet assembly.

All pneumatic tools are subject to recoil when driving fasteners. The tool may bounce, releasing the trip, and if unintentionally allowed to recontact the work surface with the trigger still actuated (finger still holding trigger pulled) an unwanted second fastener will be driven.

#### MODEL IDENTIFICATION:

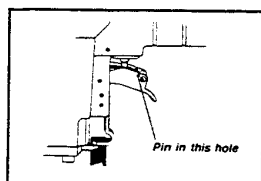

**CONTACT TRIP**  
Identified by:  
Black Trigger

Refer to Operation Instructions on page 7 before proceeding to use this tool.

#### SEQUENTIAL TRIP

The Sequential Trip requires the operator to hold the tool against the work before pulling the trigger. This makes accurate fastener placement easier, for instance on framing, toe nailing and crating applications.

The Sequential Trip allows exact fastener location without the possibility of driving a second fastener on recoil, as described under "Contact Trip".

The Sequential Trip Tool has a positive safety advantage because it will not accidentally drive a fastener if the tool is contacted against the work — or anything else — while the operator is holding the trigger pulled.

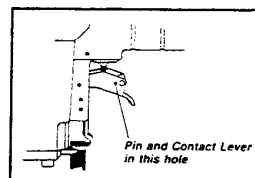

**SEQUENTIAL TRIP**  
Identified by:  
Silver Trigger

## AIR SUPPLY AND CONNECTIONS

### **▲ WARNING:**

Do not use oxygen, combustible gases, or bottled gases as a power source for this tool as tool may explode, possibly causing injury.

#### FITTINGS:

Install a male plug on the tool which is free flowing and which will release air pressure from the tool when disconnected from the supply source.

#### HOSES:

Air hoses should have a minimum of 150 p.s.i. (10.5 kg/cm<sup>2</sup>) working pressure rating or 150 percent of the maximum pressure that could be produced in the air system, whichever is higher. The supply hose should contain a fitting that will provide "quick disconnecting" from the male plug on the tool.

#### SUPPLY SOURCE:

Use only clean regulated compressed air as a power source for this tool. **NEVER USE OXYGEN, COMBUSTIBLE GASES, OR BOTTLED GASES, AS A POWER SOURCE FOR THIS TOOL AS TOOL MAY EXPLODE.**

#### REGULATOR:

A pressure regulator with an operating pressure of 0 - 125 p.s.i. is required to control the operating pressure for safe operation of this tool. Do not connect this tool to air pressure which can potentially exceed 200 p.s.i. as tool may fracture or burst, possibly causing injury.

#### OPERATING PRESSURE:

Do not exceed recommended maximum operating pressure as tool wear will be greatly increased. The air supply must be capable of maintaining the operating pressure at the tool. Pressure drops in the air supply can reduce the tool's driving power. Refer to "TOOL SPECIFICATIONS" for setting the correct operating pressure for the tool.

#### FILTER:

Dirt and water in the air supply are major causes of wear in pneumatic tools. A filter will help to get the best performance and minimum wear from the tool. The filter must have adequate flow capacity for the specific installation. The filter has to be kept clean to be effective in providing clean compressed air to the tool. Consult the manufacturers instructions on proper maintenance of your filter. A dirty and clogged filter will cause a pressure drop which will reduce the tool's performance.

## LUBRICATION

Frequent, but not excessive, lubrication is required for best performance. Oil added thru the air line connection will lubricate the internal parts. Use STANLEY-BOSTITCH Air Tool Lubricant, Mobil Velocite #10, or equivalent. Do not use detergent oil or additives as these lubricants will cause accelerated wear to the seals and bumpers in the tool, resulting in poor tool performance and frequent tool maintenance.

If no airline lubricator is used, add oil during use into the air fitting on the tool once or twice a day. Only a few drops of oil at a time is necessary. Too much oil will only collect inside the tool and will be noticeable in the exhaust cycle.

#### COLD WEATHER OPERATION:

For cold weather operation, near and below freezing, the moisture in the air line may freeze and prevent tool operation. We recommend the use of STANLEY-BOSTITCH WINTER FORMULA air tool lubricant or permanent antifreeze (ethylene glycol) as a cold weather lubricant.

**CAUTION:** To prevent frost or ice formation on the tool's operating valves and mechanisms that could cause tool failure, do not store tools in a cold weather environment.

**NOTE:** Some commercial air line drying liquids are harmful to "O"-rings and seals — do not use these low temperature air dryers without checking compatibility.

## LOADING THE N12 SERIES NAILER

### ▲ WARNING:

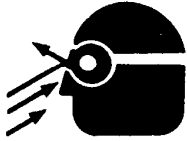

**EYE PROTECTION** which conforms to ANSI specifications and provides protection against flying particles both from the FRONT and SIDE should ALWAYS be worn by the operator and others in the work area when loading, operating or servicing this tool. Eye protection is required to guard against flying fasteners and debris, which could cause severe eye injury.

The employer and/or user must ensure that proper eye protection is worn. Eye protection equipment must conform to the requirements of the American National Standards Institute, ANSI Z87.1-1979 and provide both frontal and side protection. NOTE: Non-side shielded spectacles and face shields alone do not provide adequate protection.

- 1) Open the magazine.  
Pull down door latch and swing door open.  
Swing magazine cover open.

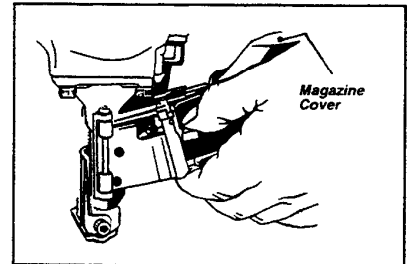

- 2) Check adjustment:  
The nailer must be set for the length of nail to be used. Nails will not feed smoothly if the magazine is not correctly adjusted. The magazine contains an adjustable nail platform on which the nail coil rests. The nail platform can be moved up and down to three settings. To change setting pull up on the post and twist to the correct step.

1-3/4" (45 mm) nails—use bottom step

1-1/4", 1-1/2" (32, 38 mm)—use middle step

7/8", 1" (22, 25 mm)—use top step

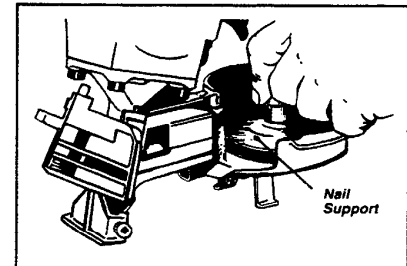

- 3) Load the coil of nails:  
Place the coil of nails over the post in the magazine. Uncoil enough nails to reach the feed pawl. Place the first nail in front of the front tooth on the feed pawl, in the driver channel. The nail heads must be in the slot in the nose.

**NOTE: Use only nails recommended by Stanley-Bostitch N12 series nailers or nails which meet the Stanley-Bostitch specifications.**

- 4) Close the Door and the Magazine Cover:  
Swing the door and the magazine cover closed. Check that the latch pin engages when released and that the magazine cover is behind the latch. The door and magazine cover may be closed in any sequence.

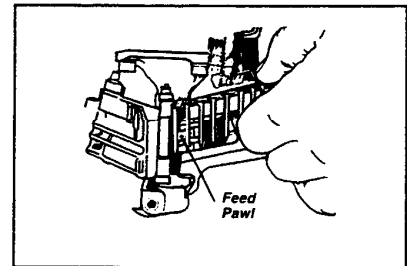

## SHINGLE GAUGE

This gauge can be used to control shingle spacing. Loosen two screws to adjust gauge to desired shingle exposure, as shown.

**WARNING: Disconnect air supply before making adjustments.**

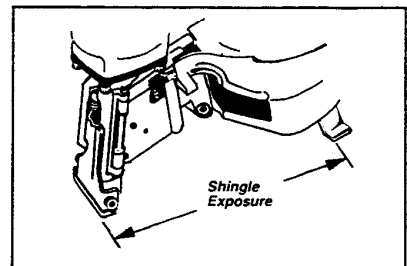

## TOOL OPERATION

### **▲ WARNING:**

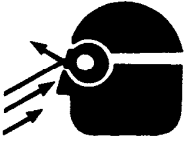

**EYE PROTECTION** which conforms to ANSI specifications and provides protection against flying particles both from the **FRONT** and **SIDE** should **ALWAYS** be worn by the operator and others in the work area when loading, operating or servicing this tool. Eye protection is required to guard against flying fasteners and debris, which could cause severe eye injury.

The employer and/or user must ensure that proper eye protection is worn. Eye protection equipment must conform to the requirements of the American National Standards Institute, ANSI Z87.1—1979 and provide both frontal and side protection. **NOTE:** Non-side shielded spectacles and face shields alone do not provide adequate protection.

### **BEFORE HANDLING OR OPERATING THIS TOOL:**

- I. READ AND UNDERSTAND THE WARNINGS CONTAINED IN THIS MANUAL.**
- II. REFER TO "TOOL SPECIFICATIONS" IN THIS MANUAL, TO IDENTIFY THE OPERATING SYSTEM ON YOUR TOOL.**

There are three available operating systems on STANLEY-BOSTITCH pneumatic tools. They are:

1. TRIGGER OPERATION
2. CONTACT TRIP OPERATION
3. SEQUENTIAL TRIP OPERATION

## OPERATION

### 1. TRIGGER OPERATION:

A TRIGGER OPERATED tool requires a single action to drive a fastener. Each time the trigger is pulled the tool will drive a fastener. The trigger operated model is intended for use only when a contact trip or sequential trip cannot be used due to the requirements of the application.

### 2. CONTACT TRIP OPERATION:

THE CONTACT TRIP MODEL tool contains a work contacting arm that operates in conjunction with the trigger to drive a fastener. There are two methods of operation to drive fasteners with a contact trip tool.

A. **SINGLE FASTENER PLACEMENT:** To operate the tool in this manner, position the nose of the tool on the work surface, WITH FINGER OFF THE TRIGGER, and depress the contact trip. Pull the trigger to drive a fastener and remove your finger from the trigger after each operation.

B. **RAPID FASTENER OPERATION:** To operate the tool in this manner, pull the trigger with the tool off the work surface. To drive fasteners, "tap" the nose of the tool against the work surface using a "bouncing" motion. Each depression of the contact trip will drive a fastener.

### **▲ WARNING:**

The operator must not hold the trigger pulled on contact trip tools except during fastening operation, as serious injury could result if the trip accidentally contacted someone or something, causing the tool to cycle.

### **▲ WARNING:**

Keep hands and body away from the discharge area of the tool. A contact trip tool may bounce from the recoil of driving a fastener and an unwanted second fastener may be driven, possibly causing injury.

### OPERATOR NOTE:

Do not press the tool against the work surface with "extra force" but instead allow the tool to recoil off the work surface to avoid a second unwanted fastener.

### 3. SEQUENTIAL TRIP OPERATION:

THE SEQUENTIAL TRIP MODEL contains a work contacting arm that operates in conjunction with the trigger to drive a fastener. There is only one method of operation to drive fasteners with a sequential trip tool, and that is single fastener placement. To operate the tool, release the trigger, press the nose of the tool on the work surface, then pull the trigger to drive a fastener. This sequence must be performed for each fastener to be driven.

The Sequential Trip Model provides a positive safety advantage because it will not accidentally drive a fastener if the nose of the tool is unintentionally allowed to recontact the work surface or anything else, with finger on the trigger.

## TOOL OPERATION CHECK:

**CAUTION:** Remove all fasteners from tool before performing tool operation check.

### 1. TRIGGER OPERATED TOOL:

- A. With finger off the trigger, hold the tool with a firm grip on the handle.
- B. Place the nose of the tool against the work surface.
- C. Pull the trigger to drive. Release the trigger and cycle is complete.

**CAUTION:** THE TOOL WILL CYCLE EACH TIME THE TRIGGER IS PULLED!

### 2. CONTACT TRIP OPERATION:

- A. With finger off the trigger, press the contact trip against the work surface.  
**THE TOOL MUST NOT CYCLE.**
- B. Hold the tool off the work surface, and pull the trigger.  
**THE TOOL MUST NOT CYCLE.**
- C. With the tool off the work surface, pull the trigger. Press the contact trip against the work surface.  
**THE TOOL MUST CYCLE.**
- D. Without touching the trigger, press the contact trip against the work surface, then pull the trigger.  
**THE TOOL MUST CYCLE.**

### 3. SEQUENTIAL TRIP OPERATION:

- A. Press the contact trip against the work surface, without touching the trigger.  
**THE TOOL MUST NOT CYCLE.**
- B. Hold the tool off the work surface and pull the trigger.  
**THE TOOL MUST NOT CYCLE.**  
Release the trigger. The trigger must return to the trigger stop on the frame.
- C. Pull the trigger and press the contact trip against the work surface.  
**THE TOOL MUST NOT CYCLE.**
- D. With finger off the trigger, press the contact trip against the work surface. Pull the trigger.  
**THE TOOL MUST CYCLE.**

---

## IN ADDITION TO THE OTHER WARNINGS CONTAINED IN THIS MANUAL OBSERVE THE FOLLOWING FOR SAFE OPERATION

- Use the STANLEY-BOSTITCH pneumatic tool only for the purpose for which it was designed.
- Never use this tool in a manner that could cause a fastener to be directed toward the user or others in the work area.
- Do not use the tool as a hammer.
- Always carry the tool by the handle. Never carry the tool by the air hose.
- Do not alter or modify this tool from the original design or function without approval by STANLEY-BOSTITCH, INC.
- Always be aware that misuse and improper handling of this tool can cause injury to yourself and others.
- Never clamp or tape the trigger or contact trip in an actuated position.
- Never leave a tool unattended with the air hose attached.
- Do not operate this tool if it does not contain a legible WARNING LABEL.

**NOTE:** Do not continue to use a tool that leaks air or does not function properly. Notify your nearest Stanley-Bostitch representative if your tool continues to experience functional problems.



## BASIC TOOL OPERATION:

STANLEY-BOSTITCH pneumatic tools are cycled by a compressed air operated single piston design. The following illustrations show the four functional cycles that occur when the tool is operated to drive a fastener:

### BASIC SINGLE PISTON STAPLER/NAILER

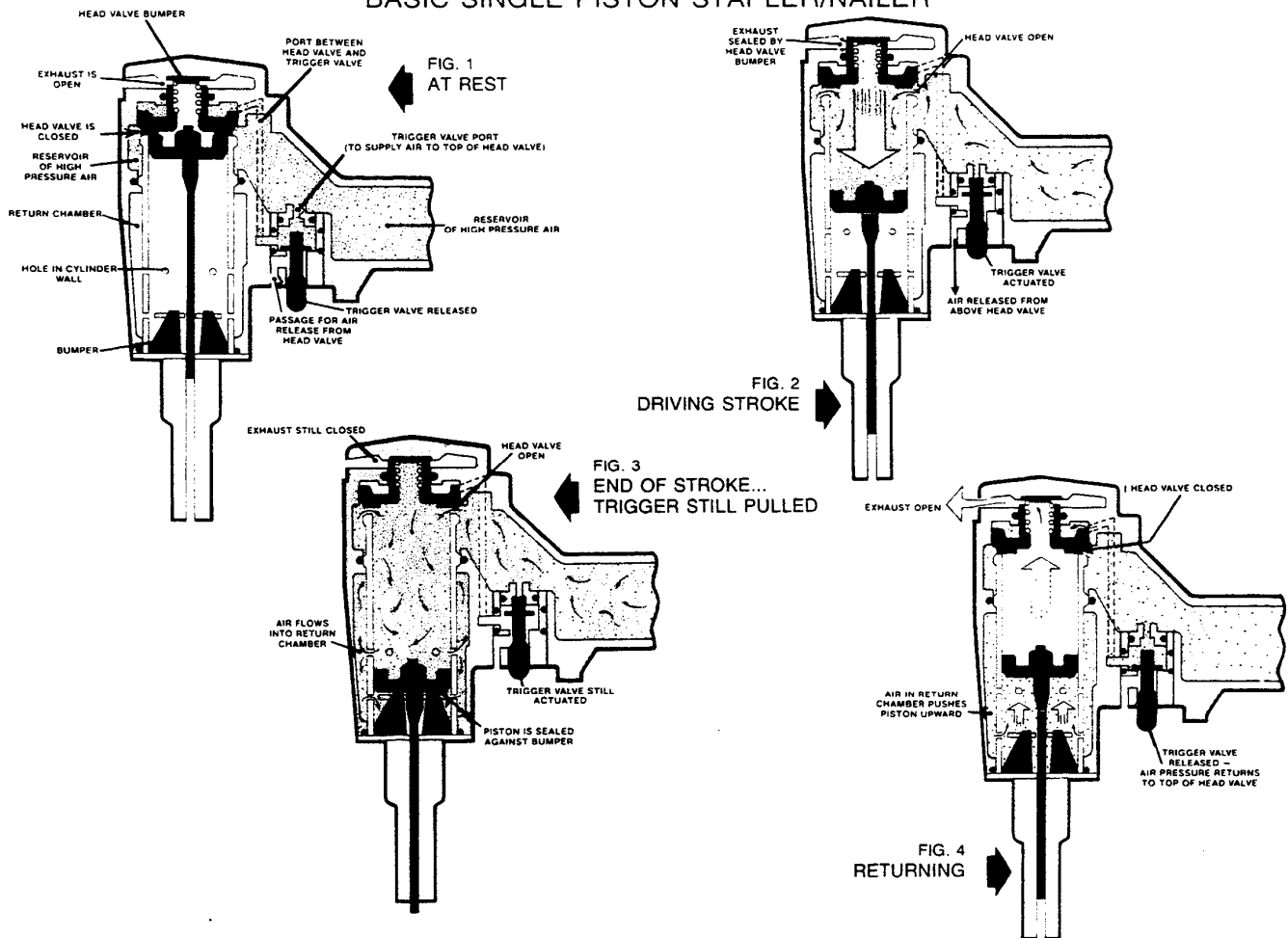

## MAINTAINING THE PNEUMATIC TOOL

**⚠ WARNING:** When working on air tools, note the warnings in this manual and use extra care evaluating problem tools.

**CAUTION:** Pusher spring (constant force spring). Caution must be used when working with the spring assembly. The spring is wrapped around, but not attached to, a roller. If the spring is extended beyond its length, the end will come off the roller and the spring will roll up with a snap, with a chance of pinching your hand. Also the edges of the spring are very thin and could cut. Care must also be taken to insure no permanent kinks are put in the spring as this will reduce the spring's force.

### REPLACEMENT PARTS:

STAN-TECH replacement parts are recommended. Do not use modified parts or parts which will not give equivalent performance to the original equipment.

### ASSEMBLY PROCEDURE FOR SEALS:

When repairing a tool, make sure the internal parts are clean and lubricated. Use Parker "O"-LUBE or equivalent on all "O"-rings. Coat each "O"-ring with "O"-LUBE before assembling. Use a small amount of oil on all moving surfaces and pivots. After reassembly add a few drops of approved Air Tool Lubricant through the air line fitting before testing.

### AIR SUPPLY-PRESSURE AND VOLUME:

Air volume is as important as air pressure. The air volume supplied to the tool may be inadequate because of undersize fittings and hoses, or from the effects of dirt and water in the system. Restricted air flow will prevent the tool from receiving an adequate volume of air, even though the pressure reading is high. The results will be slow operation, misfeeds or reduced driving power. Before evaluating tool problems for these symptoms, trace the air supply from the tool to the supply source for restrictive connectors, swivel fittings, low points containing water and anything else that would prevent full volume flow of air to the tool.

## TROUBLE SHOOTING

PROBLEM	CAUSE	CORRECTION	
Trigger valve housing leaks air	O-ring cut or cracked	Replace O-ring	
Trigger valve stem leaks air	O-ring/seals cut or cracked	Replace O-ring/seals	
Frame/nose leaks air	Loose nose screws	Tighten and recheck	
	O-ring or Gasket is cut or cracked	Replace O-ring or Gasket	
	Bumper cracked/worn	Replace bumper	
Frame/cap leaks air	Cracked gasket	Replace gasket	
	Cracked/worn head valve bumper	Replace bumper	
	Loose cap screws	Tighten and recheck	
Failure to cycle	Air supply restriction	Check air supply equipment	
	Tool dry, lack of lubrication	Use STANLEY-BOSTITCH Air Tool Lubricant	
	Worn head valve O-rings	Replace O-rings	
	Broken cylinder cap spring	Replace cylinder cap spring	
	Head valve stuck in cap	Disassemble/Check/Lubricate	
Lack of power Slow to cycle	Tool dry, lacks lubrication	Use STANLEY-BOSTITCH Air Tool Lubricant	
	Broken cylinder cap spring	Replace cap spring	
	O-rings/seals cut or cracked	Replace O-rings/seals	
	Exhaust blocked	Check bumper, head valve spring	
	Trigger assembly worn/leaks	Replace trigger assembly	
	Dirt/tar build up on driver	Disassemble nose/driver to clean	
	Cylinder sleeve not seated correctly on bottom bumper	Disassemble to correct	
	Head valve dry	Disassemble/lubricate	
	Air pressure too low	Check air supply equipment	
	Skipping fasteners Intermittent feed	Worn bumper	Replace bumper
Tar/dirt in driver channel		Disassemble and clean nose and driver	
Air restriction/inadequate air flow through quick disconnect socket & plug		Replace quick disconnect fittings	
Worn piston O-ring		Replace O-ring, check driver	
Tool dry, lacks lubrication		Use STANLEY-BOSTITCH Air Tool Lubricant	
Damaged pusher spring		Replace spring	
Low air pressure		Check air supply system to tool	
Loose magazine nose screws		Tighten all screws	
Fasteners too short for tool		Use only recommended fasteners	
Bent fasteners		Discontinue using these fasteners	
Wrong size fasteners		Use only recommended fasteners	
Leaking head cap gasket		Tighten screws/replace gasket	
Trigger valve O-ring cut/worn		Replace O-ring	
Broken/chipped driver		Replace driver (check piston O-ring)	
Dry/dirty magazine		Clean/lubricate use STANLEY-BOSTITCH Air Tool Lubricant	
Worn magazine		Replace magazine	
Fasteners jam in tool		Driver channel worn	Replace nose/check door
		Wrong size fasteners	Use only recommended fasteners
	Bent fasteners	Discontinue using these fasteners	
	Loose magazine/nose screws	Tighten all screws	
	Broken/chipped driver	Replace driver	

## COIL NAILERS

Skipping fasteners Intermittent feed	Feed piston dry	Add STANLEY-BOSTITCH Air Tool Lubricant in hole in feed piston cover
	Feed piston O-rings cracked/worn	Replace O-rings/check bumper and spring. Lubricate assembly.
	Check Pawl binding	Inspect Pawl and spring on door. Must work freely.
	Canister bottom not set correctly	Set canister bottom for length of nails being used.
	Broken weld wires in nail coil	Discontinue using
Fasteners jam in tool/canister	Wrong size fasteners for tool	Use only recommended fasteners/check canister bottom adjustment
	Broken welded wires in nail coil	Discontinue using
	Wrong slide plate adjustment for wire/plastic collated nail coil	Adjust switch pins for wire/plastic collated nail coil

## CLEANING THE ROOFING NAILER

**▲ WARNING:** Do not use gasoline or similar highly flammable liquids to clean the nailer. Vapor could be ignited by a spark causing an explosion.

Tar and dirt may build up on the nose and trip lever. This can prevent correct operation. Remove any buildup with kerosene, #2 fuel oil or diesel fuel. Do not dunk the nailer into these solvents beyond the height of the nail heads, to avoid getting the solvent into the drive cylinder.

Dry off the nailer before use. Any oil film left after cleanup will accelerate the tar buildup, and the nailer will require more frequent re-cleaning.

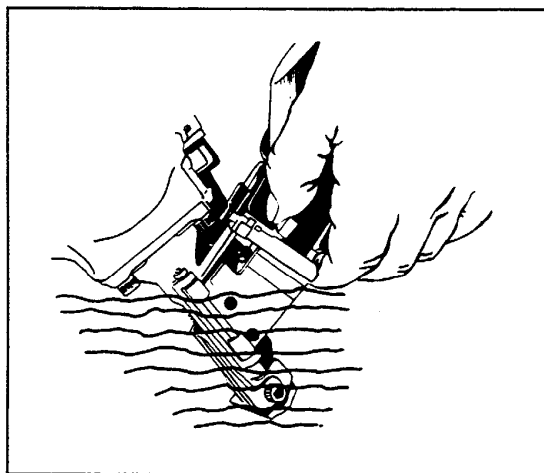

**NOTE:** Solvents sprayed on nose to clean and free up the trip may have the opposite effect! The solvent may soften the tar on the shingles and cause tar buildup to be accelerated. Dry operation is better, as noted above.

## PARTS LIST FOR BODY

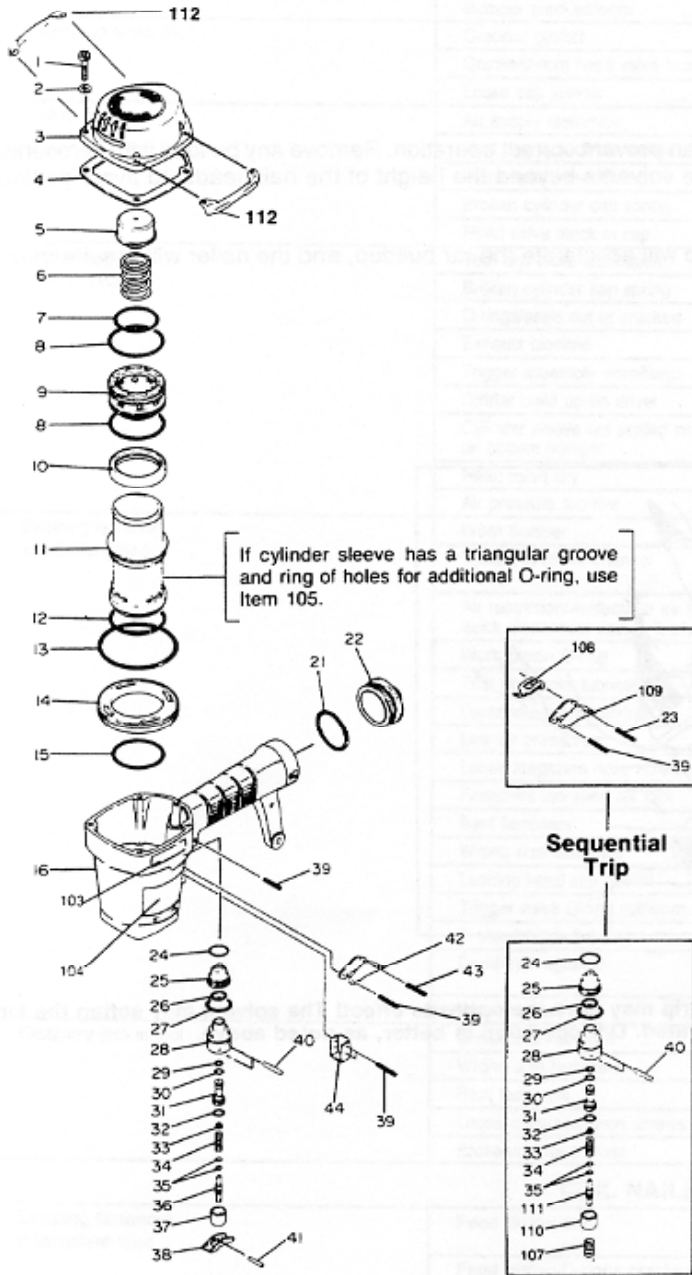

Item No.	Part No.	Description
1	MSC6100-22	Screw 6mm x 22mm
2	MPW6.2	Plain Washer
3	CN31422	Cap Assembly
4	N12144	Gasket
5	CN31425	Exhaust Bumper
6	854016	Head Valve Spring
7	MRG039735	O-Ring H.V.I.D.
8	850007	O-Ring H.V.O.D.
9	CN31426	Head Valve
10	CN31428	Head Valve Seal
11	CN31427	Cylinder Sleeve
12	850006	O-Ring Sleeve OD
13	MRG074431	O-Ring Bulkhead OD
14	CN31429	Bulkhead Ring
15	MRG049020	O-Ring Sleeve Lower
16	CN31421	Frame
21	MRG034826	O-Ring End Cap
22	T40207	Handle End Cap
24	86459	O-Ring
25	CN31433	Trigger Valve Cap Assy.
26	851284	O-Ring
27	MRG019824	O-Ring Valve Body
28	CN31435	Trigger Valve Housing
29	MRG005819	O-Ring 1AP6
30	MRG006819	O-Ring 1BP7
31	CN31589	Pilot Valve
32	MRG008819	O-Ring 1AP9
33	CN31436	Poppet Orifice Plate
34	KK23129	Compression Spring —3129
***35	MRG002514	O-Ring 1B 1.4 x 2.5
36	CN31437	Trigger Stem
37	CN31346	Trigger Valve Cap
38	CN31438	Rocker
39	MPG030025	Roll Pin 3mm x 25mm
40	UB2108	Straight Pin 161
41	UB2107	Rocker Pin
42	CN30646	Trigger
43	MPG017016	Roll Pin
44	CN31439	Trip Lever Guide
*102	854005	Hex Bar Wrench 5mm
103	851882S	Stanley-Bostitch Label
104	851392	Warning Label
105	HH11170	O-Ring
***107	KK23228	Spring 3228
***108	CN31717	Contact Lever
***109	CN31718	Trigger
***110	CN31716	Trigger Valve Cap
***111	CN31715	Trigger Valve Stem
112	N55020	Wear Plate
113	N55021	Tool Support

\* Long pattern 5mm Hex wrench is available as 851288  
 \*\*\* These parts are included with Sequential Trip Kit N12K5

## PARTS LIST FOR MAGAZINE

Item No.	Part No.	Description	Item No.	Part No.	Description
45	CN65042	Nut	74	N12020	Door Hinge Pin
46	MCW10	Washer, Piston Upper	75	CN31452	Holding Pawl
47	MRG037735	O-Ring	76	854011	Compression Spring —3109
48	CN31430	Piston	77	CN31704	Kickback Pawl
49	N12118	Washer, Piston Lower	78	MSC6100-35	Screw 6mm x 35mm
50	CN31431	Driver	79	N12120	Pawl Pivot Pin
51	CN31444	Driver Guide Front	80	CN31703	Door
52	CN31706	Driver Guide Back	81	MPG030008	Latch Retainer Pin
53	CN31432	Drive Bumper	82	854013	Latch Spring
54	CN31462	Trip Cover	83	CN31077	Door Latch
55	MHE6100-100	Elastic Stop Nut M6 x 1	84	MSC6100-12	Screw 6mm x 12mm
56	MSC6100-22	Screw 6mm x 22mm	85	MLW6	Lock Washer
57	N12145	Spring, Trip Lever	86	MPW6	Plain Washer
58	CN31440	Trip Lever	87	CN31461	Gauge
59	MSC6100-10	Screw 6mm x 10mm	88	CN31463	Gauge Nut Plate
60	MRG003617	O-Ring Nose Port	89	N12113	Post Retainer
61	CN31702	Feed Pawl	90	CN30602	Receiver, Spring
62	MPG030012	Roll Pin	91	854008	Spring
63	N12112	Hinge Pin Retainer	92	CN31454	Magazine
64	MRB019	Retaining Ring	93	CN31458	Magazine Wear Clip
65	MRG013926	O-Ring Feed Piston Cap	94	CN30601	Spacer
66	CN31448	Feed Piston Cap	95	CN31705	Magazine Post
67	CN30578	Feed Piston Bumper	96	CN30703	Magazine Bushing
68	CN31447	Feed Piston	97	MPW6.2	Washer 138
69	RG036407	O-Ring Piston Stem	98	CN31455	Platform Assembly
70	854024	Spring, Feed Pawl	99	N12021	Cover Hinge Pin
71	N12022	Feed Pawl Pin	100	CN31460	Gauge Bracket
72	CN31701	Nose	101	CN31459	Magazine Cover
73	CN31441	Trip Foot Assembly	106	CN31468	Cover Retainer

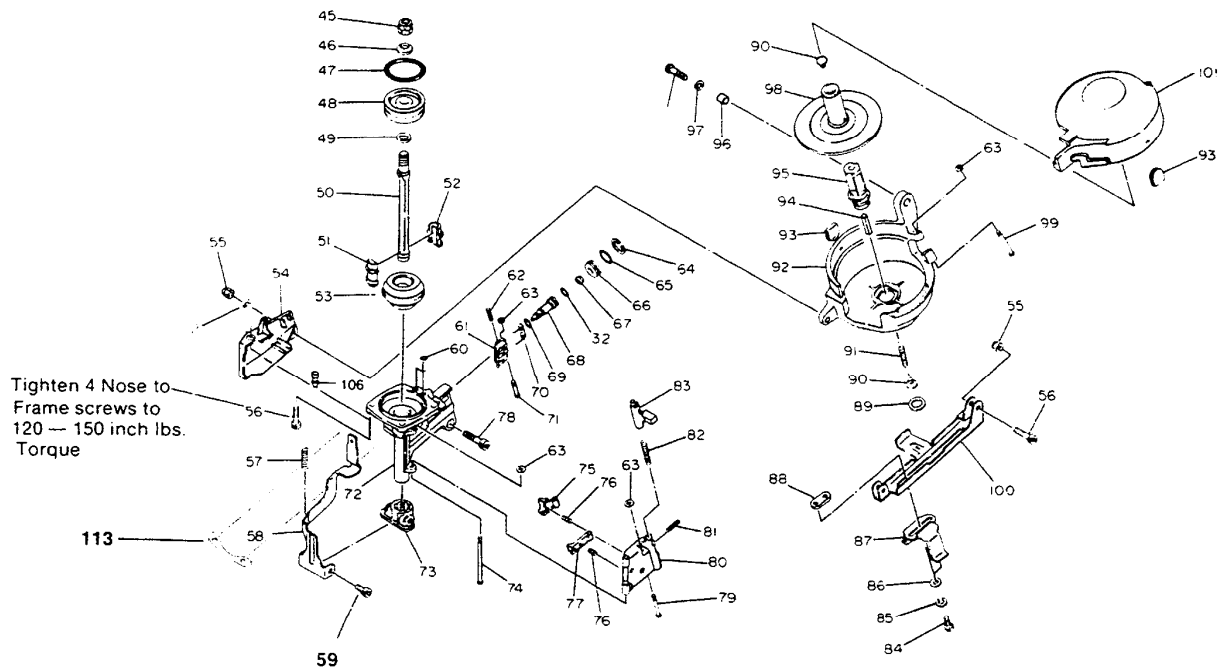

Use Loctite #271 or equivalent when assembling these two screws.  
Loctite #271 Packet is available as Part No. 851325.

### TOOL MAINTENANCE/SERVICE RECORD

## AVAILABLE ACCESSORIES

---

BK4	Bumper Kit
N12K1	Spare Parts Kit
DC1	Dial-A-Depth™ Kit (N12)
VSA1	Vinyl Siding Adaptor Kit
N12K5	Sequential Trip Conversion Kit
ORK4	O-Ring Kit
BC601	4oz. Bottle of Stanley-Bostitch Air Tool Lubricant
BC602	1pt. Stanley-Bostitch Air Tool Lubricant
BC603	1pt. Stanley-Bostitch "Winter" Formula Lubricant
BC604	1 Quart Stanley-Bostitch Air Tool Lubricant
86524	4oz. Tube O-Ring Lube

## LIMITED WARRANTY

Stanley-Bostitch, Inc., warrants to the original retail purchaser that this product is free from defects in material and workmanship, and agrees to repair or replace, at Stanley-Bostitch's option, any defective product within 90 days from the date of purchase. This warranty is not transferable. It only covers damage resulting from defects in material or workmanship, and it does not cover conditions or malfunctions resulting from normal wear, neglect, abuse or accident.

THIS WARRANTY IS IN LIEU OF ALL OTHER EXPRESS WARRANTIES. ANY WARRANTY OF MERCHANTABILITY OR FITNESS FOR A PARTICULAR PURPOSE IS LIMITED TO THE DURATION OF THIS WARRANTY. STANLEY-BOSTITCH SHALL NOT BE LIABLE FOR ANY INCIDENTAL OR CONSEQUENTIAL DAMAGES.

Some states do not allow limitations on how long an implied warranty lasts, or the exclusion or limitation of incidental or consequential damages, so the above limitations or exclusions may not apply to you. This warranty gives you specific legal rights, and you may also have other rights which vary from state to state.

To obtain warranty service, you must return the product at your expense together with proof of purchase to a Stanley-Bostitch Regional warranty repair center listed below or you may call us at 1-800-832-3080 for the location of additional authorized warranty service locations in your area.

**EASTERN:** Stanley-Bostitch, Inc., 1 Feltloc Lane, East Greenwich, R.I. 02818

**MIDWEST:** Stanley-Bostitch, Inc., 420 South Kitley Avenue, P.O. Box 19329, Indianapolis, IN 46219

**SOUTHERN:** Stanley-Bostitch, Inc., 1105 Satellite Blvd. Suite 105, Suwanee, GA 30174

**WESTERN:** Stanley-Bostitch, Inc., 6941 West Goshen Avenue, P.O. Box 111, Visalia, CA 93277

To find the Stanley-Bostitch service location nearest you, please call:

**1-800-832-3080**