



Instruction Manual

3157-220 Variable Speed Orbital Action Jig Saw

Getting the most out of your tool.

Please take time to read this manual and pay particular attention to the safety rules we've provided for your protection. If you have any questions about your tool please call:

1-800-9-BD TOOL
(1-800-923-8665)

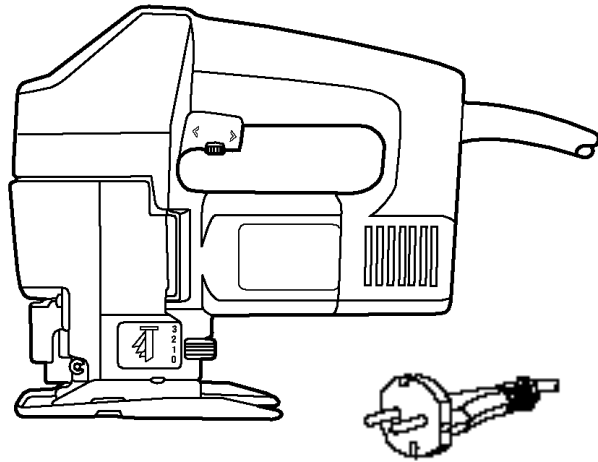

3157-220 Variable Speed Orbital Action Jig Saw with 220 volt plug

IMPORTANT SAFETY INSTRUCTIONS

WARNING: When using electric tools, basic safety precautions should always be followed to reduce risk of fire, electric shock, and personal injury, including the following:

READ ALL INSTRUCTIONS

Double Insulation

Double insulated tools are constructed throughout with two separate layers of electrical insulation or one double thickness of insulation between you and the tool's electrical system. Tools built with this insulation system are not intended to be grounded. As a result, your tool is equipped with a two prong plug which permits you to use extension cords without concern for maintaining a ground connection.

NOTE: Double insulation does not take the place of normal safety precautions when operating this tool. The insulation system is for added protection against injury resulting from a possible electrical insulation failure within the tool.

CAUTION: WHEN SERVICING USE ONLY IDENTICAL REPLACEMENT PARTS. Repair or replace damaged cords.

Safety Instructions For All Tools

- **KEEP WORK AREA CLEAN.** Cluttered areas and benches invite injuries.
- **CONSIDER WORK AREA ENVIRONMENT.** Don't expose power tools to rain. Don't use power tools in damp or wet locations. Keep work area well lit. Do not use tool in presence of flammable liquids or gases.
- **GUARD AGAINST ELECTRIC SHOCK.** Prevent body contact with grounded surfaces. For example; pipes, radiators, ranges, and refrigerator enclosures.
- **KEEP CHILDREN AWAY.** Do not let visitors contact tool or extension cord. All visitors should be kept away from work area.
- **STORE IDLE TOOLS.** When not in use, tools should be stored in dry, and high or locked-up place — out of reach of children.
- **DON'T FORCE TOOL.** It will do the job better and safer at the rate for which it was intended.
- **USE RIGHT TOOL.** Don't force small tool or attachment to do the job of a heavy-duty tool. Don't use tool for purpose not intended.
- **DRESS PROPERLY.** Do not wear loose clothing or jewelry. They can be caught in moving parts. Rubber gloves and non-skid footwear are recommended when working outdoors. Wear protective hair covering to contain long hair.
- **USE SAFETY GLASSES.** Also use face or dust mask if cutting operation is dusty.
- **DON'T ABUSE CORD.** Never carry tool by cord or yank it to disconnect from receptacle. Keep cord from heat, oil, and sharp edges.
- **SECURE WORK.** Use clamps or a vise to hold work. It's safer than using your hand and it frees both hands to operate tool.
- **DON'T OVERREACH.** Keep proper footing and balance at all times.
- **MAINTAIN TOOLS WITH CARE.** Keep tools sharp and clean for better and safer performance. Follow instructions for lubricating and changing accessories. Inspect tool cords periodically and if damaged, have repaired by authorized service facility. Inspect extension cords periodically and replace if damaged. Keep handles dry, clean, and free from oil and grease.

- **DISCONNECT OR LOCK OFF TOOLS** when not in use, before servicing, and when changing accessories, such as blades, bits, cutters.
- **REMOVE ADJUSTING KEYS AND WRENCHES.** Form habit of checking to see that keys and adjusting wrenches are removed from tool before turning it on.
- **AVOID UNINTENTIONAL STARTING.** Don't carry tool with finger on switch. Be sure switch is off when plugging in.
- **EXTENSION CORDS.** Make sure your extension cord is in good condition. When using an extension cord, be sure to use one heavy enough to carry the current your product will draw. An undersized cord will cause a drop in line voltage resulting in loss of power and overheating. The following table shows the correct size to use depending on cord length and nameplate ampere rating. If in doubt, use the next heavier gage. The smaller the gage number, the heavier the cord.

Minimum Gage for Cord Sets

Volts	Total Length of Cord in Feet			
	0-25	26-50	51-100	101-150
120V	0-25	26-50	51-100	101-150
240V	0-50	51-100	101-200	201-300
Ampere Rating		AWG		
More Than	Not more Than			
0	- 6	18	16	16 14
6	- 10	18	16	14 12
10	- 12	16	16	14 12
12	- 16	14	12	Not Recommended

- **OUTDOOR USE EXTENSION CORDS.** When tool is used outdoors, use only extension cords intended for use outdoors and so marked.
- **STAY ALERT.** Watch what you are doing. Use common sense. Do not operate tool when you are tired.
- **CHECK DAMAGED PARTS.** Before further use of the tool, a guard or other part that is damaged should be carefully checked to determine that it will operate properly and perform its intended function. Check for alignment of moving parts, binding of moving parts, breakage of parts, mounting, and any other

conditions that may affect its operation. A guard or other part that is damaged should be properly repaired or replaced by an authorized service center unless otherwise indicated elsewhere in this instruction manual. Have defective switches replaced by authorized service center. Do not use tool if switch does not turn it on and off.

Additional Safety Instructions for Jig Saws

- **CAUTION:** When cutting into walls, floors or wherever live electrical wires may be encountered, DO NOT TOUCH ANY METAL PARTS OF THE TOOL! Hold the tool only by insulated grasping surfaces to prevent electric shock if you cut in the live wire.
- **KEEP HANDS AWAY** from cutting area. Never reach underneath the material for any reason.
- **KEEP BLADES SHARP.** Dull blades may cause the saw to swerve or stall under pressure.
- **CAUTION:** Some wood contains preservatives such as copper chromium arsenate (CCA) which can be toxic. When cutting these materials extra care should be taken to avoid inhalation and minimize skin contact.

SAVE THESE INSTRUCTIONS

TOOL OPERATION

Variable Speed Switch (Figure 1)

This switch has a button 'A' mounted in the trigger, which can be rotated to vary the blade strokes-per-minute (S.P.M.).

(a) For 'Free Hand' speed control (the further the trigger is depressed, the higher the S.P.M.), rotates the button in the + direction (clockwise) until it stops. (b) To set the trigger switch to produce a selected speed each time the trigger is squeezed, first rotate the button toward + until it stops. Then fully depress the trigger, press in the locking button, and release the trigger. The tool will stay "ON." Now, rotate the button 'A' toward "—" and you will notice a decrease in speed. Continue rotating the button until desired speed is obtained. Pull trigger and release to turn "OFF." At this setting the saw will run at the selected speed each time the trigger is pulled and the trigger may be locked "ON" at the selected speed.

Figure 1

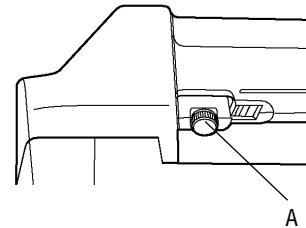
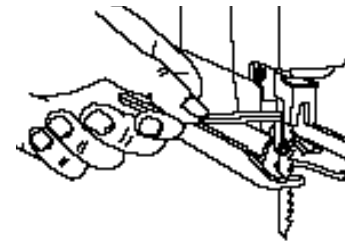

Figure 2



Inserting the Blade (Figure 2)

Cycle the tool on and off as necessary to make the blade clamp stop in a position where you can reach the blade clamping screw (Figure 2).

Never remove the blade clamp guide

Disconnect tool from extension cable or wall socket. Loosen screw at side of blade clamp. Insert blade in blade clamp as far as it will go (about 13mm). Make sure the back edge of the blade fits into the support roller and tighten the screw against the blade.

Figure 3

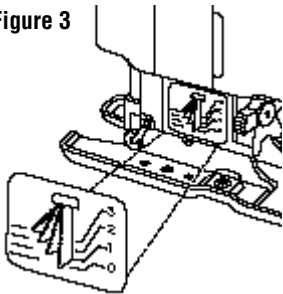

Figure 4

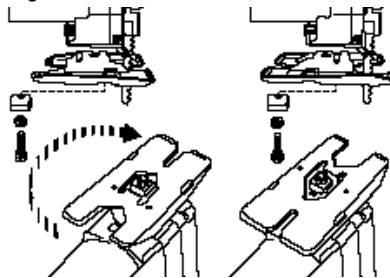

Figure 5

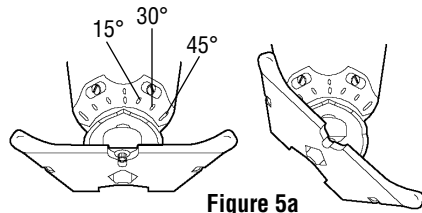
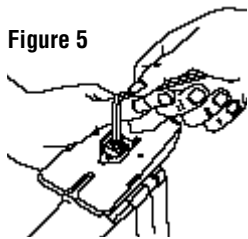

Figure 5a

Straight Line or Orbital Cutting Action (Figure 3)

Conventional jig saws cut with a straight line action, that is, the blade moves only up and down in a straight line. Your saw also cuts in this manner, but, for softer materials, an orbital cutting action can be selected. Soft materials, like wood and plastic permit deep penetration of individual saw teeth. The orbital action thrusts the blade forward on the cutting stroke and greatly increases cutting speed over conventional jig saws. Harder materials like metal should be cut using the straight line cutting action or a very low orbital setting. To select straight line or orbital cutting adjust the dial on the saw (as shown in Figure 3).

Reversing Shoe Position (Figure 4)

To reverse the shoe position remove the screw from the bottom of the tool (Figure 4) and remove the shoe from the jigsaw. Be careful to note the position of the Clamp. This clamp must be re-installed the same way or the shoe will not fit properly. Turn the shoe around and re-install noting carefully that, when the slot is forward, the screw goes through the hole in the shoe and when the wide opening is forward, the screw passes through the slot in the shoe.

NOTE: Study Figure 4 **BEFORE** reversing shoe.

Bevel Cutting Adjustment (Figure 5)

Bevel cuts may be made at any angle between 0° and 45°. The shoe is adjusted by loosening the screw on the bottom of the tool (Figure 5.) and rotating the shoe to the desired angle (Figure 5A). After setting the shoe, tighten the screw firmly and use saw in the normal manner. **NOTE:** One hand on the saw body and the other on the edge of the saw shoe, well back from the blade, may be necessary to maintain accurate cutting.

Adjustment for 90° Cuts

1. Disconnect plug from power supply.
2. Place a right angle against the blade and the shoe and adjust the shoe to 90°.
3. 0° mark on quadrant plate should line up with mark on shoe. If adjustment is necessary, loosen screw on quadrant plate and adjust as necessary.

Anti-Splintering Shoe

This jigsaw has a special double-ended with a wide opening at one end for general cutting and bevel cutting and a very narrow slot at the other end for use only with hollow ground blades. The narrow slot acts as an anti-splintering device particularly useful when cutting plywood. NOTE: Use only hollow ground blades or scrolling blades in the slotted end of the shoe. Use of any other blades will damage the shoe. The anti-splintering feature should be used only when making straight cuts or circle cuts with the U2151 Rip Fence & Circle Guide, not for bevel cutting, pocket cutting or metal cutting.

Metal Cutting

In cutting thin gage steel metals, it is best to clamp wood or plywood to the bottom of metal sheet; this will insure a clean cut without the danger of vibration or tearing of metal. Always remember to use a finer blade for ferrous metals (for those that have an iron content); and use a coarser blade for non-ferrous metals (those that do not have an iron content). Use a high speed setting for cutting soft metals (aluminum, copper, brass, mild steel, galvanized pipe, black pipe, conduit sheet metal, etc). Use lower speed to cut plastics, tile, Formica, hard metals, cast iron.

Wood Cutting

Be sure board is firmly positioned. Don't attempt to turn on when blade is against material to be cut. This could stall the motor. Place front of shoe on material to be cut and hold Jig Saw shoe down firmly against the wood while cutting. Don't force the tool; let the blade cut at its own speed. Whenever possible, clamp or support work close to the line of cut; when the cut is completed, shut off power, let blade come to a complete stop and then lay the saw aside before loosening the work. Use the higher speed setting for cutting wood.

Important

To assure product SAFETY and RELIABILITY, repairs, maintenance and adjustment (including brush inspection and replacement) should be performed by authorized service centers or other qualified service organizations, always using identical replacement parts.

Accessories

Recommended accessories for use with your tool are available at extra cost from your distributor or local service center.

CAUTION: The use of any non-recommended accessory may be hazardous.

If you need any assistance in locating any accessory call 1-800-9-BD TOOL: (1-800-923-8665) or contact Black & Decker (U.S.) Inc., Consumer Services Department, 626 Hanover Pike, P.O. Box 618, Hampstead, MD 21074.

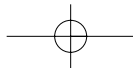

Every B&D tool is of the highest quality.
If you wish to contact us regarding this product, please call toll
free between 8:00am and 8:00pm ET, seven days a week:
1-800-9-BD TOOL
(1-800-923-8665)

NOTES

One Year Free Maintenance

All B&D tools for Industry and Construction are covered under a one year free maintenance program where B&D will inspect your tool for safety and provide necessary maintenance or repairs, including normal wear and tear parts, for one year, FREE OF CHARGE.

Full Warranty

All B&D tools for Industry and Construction are warranted to be free of any defects in materials or workmanship. Upon thorough examination of tool, B&D will repair or replace, at our option, any product that is determined to be defective.

Conditions

The service/safety check and the warranty do not apply to: repairs made or attempted by anyone other than an authorized B&D service location; misuse, abuse, neglect, improper application of the tool; missing parts; or normal wear and tear (after first year of ownership). Please return the complete unit, transportation prepaid, to any B&D factory owned or B&D authorized service center location (list provided with tool or see Yellow Pages under "Tools Electric").

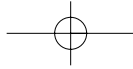
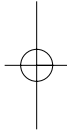
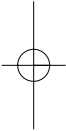

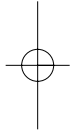
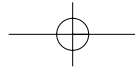

Black & Decker (U.S.) Inc. • 701 East Joppa Road, Towson, Maryland 21286
Printed in U.S.A. (FEB96-CD-1) Form No. 154570 Copyright © 1996

