

## Cleaning and Lubrication

Use only mild soap and a damp cloth to clean the tool. Other cleaners contain chemicals which could seriously damage the plastic. Never let any liquid get inside the tool; never immerse any part of the tool into a liquid.

Self-lubricating bearings are used in the tool and periodic relubrication is not required. In the unlikely event that this tool should ever require service, take or send it to your local Black & Decker Service Center. Service center addresses are listed on the owner's registration card packed with your tool.

## Screw Lubricants

In some cases it may be to your advantage to use a lubricant to make a screw drive a little easier. Three of the more common lubricants are bar soap, liquid dishwashing soap and bee's wax. Just put a little on the screw threads for easy driving.

**NOTE:** Due to variables such as grain irregularity and moisture content of the wood and the amount of charge of the Screwdriver, some of the larger size screws may be difficult to fully seat, particularly in hardwoods. In these instances the Automatic Spindle Lock feature (page 5) will be most useful.

No. 6 and smaller screws will often require a No. 1 screwdriver bit or a thinner bladed bit. Both of these are available at extra cost from Black & Decker.

**CAUTION:** When screwing into hollow core doors or drywall (unsupported) use expandable anchors. (Available at extra cost from Black & Decker.)

Screw Size	Suggested Uses	Pilot Hole Diameter*	
		Soft Wood & Composition	Hardwoods
#6	House number, Light weight wall hangings, Small cup hooks	3/32"	3/32"
#8	Curtain rods, Window locks	1/8"	5/32"
#10	Door hardware, Hinges	5/32"	5/32"

\*When in doubt about whether you are drilling into soft wood or hardwood, assume that it is soft and drill the smaller pilot hole. Then, if the screw is particularly hard to turn, drill the larger size pilot hole.

## Home Use Warranty (A Full Two Year Warranty)

Black & Decker (U.S.) Inc. warrants this product for two years against any defects that are due to faulty material or workmanship. Please return the complete unit, transportation prepaid, to the seller (if a participating retailer) for free replacement (proof of purchase may be required). The unit may also be returned to a Black & Decker Service Center or Authorized Service Station, listed under "Tools, Electric" in the yellow pages for free replacement or repair at our option. This warranty does not apply to accessories. This warranty gives you specific legal rights and you may have other rights which vary from state to state. Should you have any questions, contact your nearest Black & Decker Service Center Manager.

Like most Black & Decker tools, this tool is listed by Underwriters Laboratories to ensure that it meets stringent safety requirements.



This symbol on the nameplate means the product is listed by Underwriters Laboratories, Inc.



See 'Tools-Electric' -Yellow Pages- for Service & Sales

Form No. 741855  
Copyright © 1989 Black & Decker  
Printed in U.S.A.  
(NOV89-CO-2)



Black & Decker (U.S.) Inc., U.S. Power Tools Group, 10 North Park Drive, P.O. 798, Hunt Valley, MD 21030-0798

# BLACK&DECKER® CORDLESS

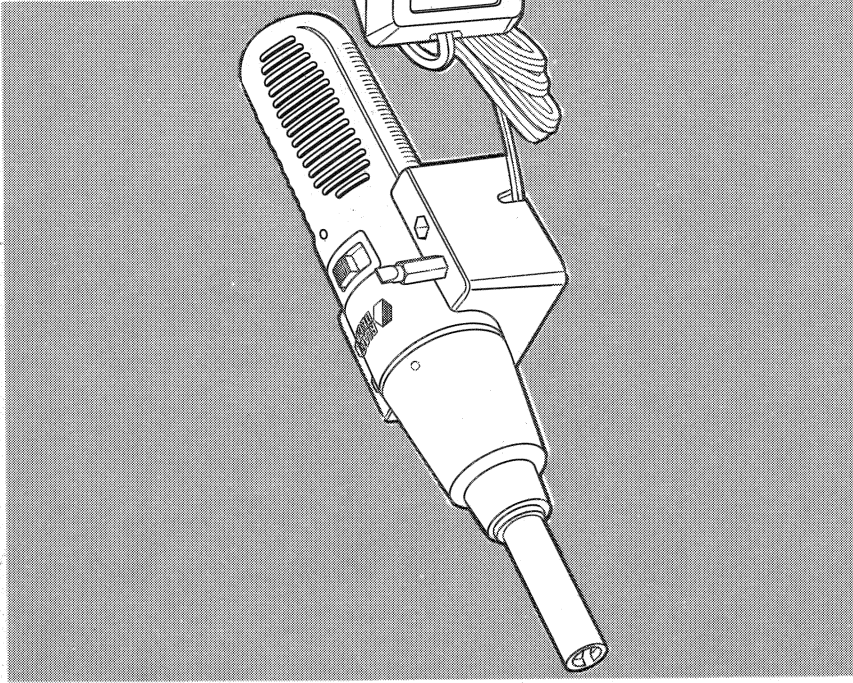

## Instruction Manual Cordless Screwdriver Plus 9038

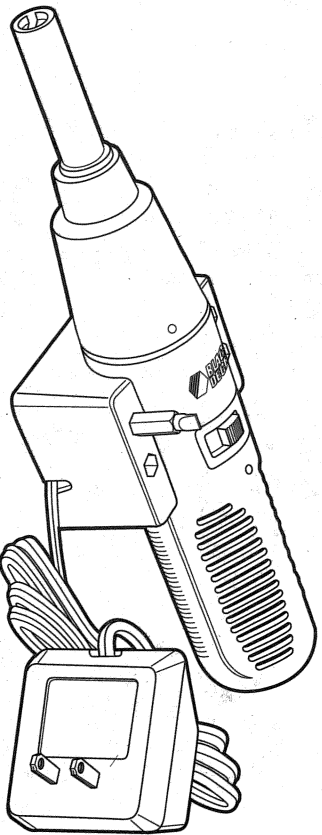

## Thanks for Buying a Black & Decker Cordless Screwdriver Plus.

As a leader in cordless tools since 1961, Black & Decker has put a lot of know-how into making the perfect tool for those frequent little jobs around the house. Tasks where you don't need a heavy duty tool or one that's way down in the workshop are just made for the 9038 Cordless Screwdriver Plus.

The tool hangs on the wall wherever you want... the kitchen, laundry, closet, wherever it's the most handy. Constantly on charge, it's always ready when you are to drive screws. It's perfect for installation, assembly and building jobs

and hundreds of other tasks in and around the home. The Screwdriver Plus is so handy and so easy to use, it makes a perfect gift for just about anyone.

All this and Black & Decker's traditional quality are sure to make your Screwdriver Plus a tool you'll count on again and again to make life easier around the house. Don't forget to send in your owner's registration card. Thanks again for bringing Black & Decker home!



### Pilot Holes

Your tool is equipped with a 1/4" shank 1/8" dia. pilot drill bit. Insert and remove this bit as you would any screwdriver bit. Note: Carefully back the bit out of the wood before removing it from the tool. When inserting or removing drill bit from screwdriver do not grip the drill bit by the cutting edges. Also be aware that the drill bit could be hot after drilling.

Pilot holes are holes drilled in wood that are slightly smaller than the screw which is to be driven. (For the purpose of this discussion, we will limit ourselves to talking about wood, although there are other materials you may encounter.) The pilot hole has two purposes. As its name suggests, it acts as a guide for the screw to follow and allows the screw to be driven with just the threads gripping the wood. This makes the screw much easier to drive and prevents distortion or splitting of the wood caused by driving the whole screw body into the wood.

Pilot holes should be drilled to a depth equal to or greater than the length of the screw to be used. When drilling in wood with a pilot bit you should reverse the bit out of the hole periodically to clear wood chips from the flutes.

Different screw sizes and materials call for different size pilot holes. A handy chart on the back page of this manual should supply you with all the pilot hole information you will need for using your Screwdriver Plus.

When reinserting a wood screw into a hole that is already threaded, start the screw by hand to avoid stripping the threads in the hole. Run the screw in until you feel the threads catch, then apply the Screwdriver Plus. See "Switch", pages 5 and 6.

### Important!

To assure product SAFETY and RELIABILITY, repairs, maintenance and adjustments should be performed by

Black & Decker Service Centers or other qualified service organizations, always using Black & Decker replacement parts. Black & Decker's full two year home use warranty states that, in case of a defect, you may return the tool to the place of purchase for a free replacement (if it is a participating retailer) or you may take it to a Black & Decker Service Center.

### Accessories

The accessories listed in this manual are available at extra cost from your local dealer or Black & Decker Service Center. A complete listing of service centers is included on the owner's registration card packed with your tool.

If you need assistance in locating any accessory, please contact:  
Black & Decker (U.S.) Inc.  
Consumer Services Dept.  
U.S. Power Tools Group  
626 Hanover Pike  
P.O. Box 618  
Hampstead, MD 21074-0618

Every Black & Decker tool is of the highest quality. If you wish to contact us regarding this product, please call toll free between 8:00 and 5:00 p.m. EST, Monday through Friday. 1-800-762-6672

Your Screwdriver Plus is designed to operate with the following accessories only. The use of any accessory or attachment not recommended below may be hazardous.

#### SCREWDRIVER BITS

All Black & Decker sizes and configurations.

#### SCREWDRIVER BIT TIPS

Do not use bit tips without a magnetic bit tip holder.

#### SOCKETS & NUT DRIVERS

Black & Decker hex sockets and nut drivers up to 3/8" maximum.

#### DRILL BITS

Catalog No. 16193 1/4" shank drill bits (selection of 4 bits: 1/16", 3/32", 1/8" & 5/32")

## IMPORTANT SAFETY INSTRUCTIONS

**WARNING:** When using Electric Tools, basic safety precautions should always be followed to reduce the risk of fire, electric shock, and personal injury, including the following:

### READ ALL INSTRUCTIONS

1. **KEEP WORK AREA CLEAN.** Cluttered areas and benches invite injuries.
2. **CONSIDER WORK AREA ENVIRONMENT.** Don't expose power tools to rain. Don't use power tools in damp or wet locations. Keep work area well lit.
3. **GUARD AGAINST ELECTRIC SHOCK.** Prevent body contact with grounded surfaces. For example: pipes, radiators, ranges, refrigerator enclosures.
4. **KEEP CHILDREN AWAY.** All visitors should be kept away from work area. Do not let visitors contact tool.
5. **STORE IDLE TOOLS.** When not in use, tools should be stored in dry, high or locked-up place - out of reach of children.
6. **DON'T FORCE TOOL.** It will do the job better and safer at the rate for which it was intended.
7. **USE RIGHT TOOL.** Don't force small tool or attachment to do the job of a heavy-duty tool. Don't use tool for purpose not intended, for example, don't use circular saw for cutting tree limbs or logs.
8. **DRESS PROPERLY.** Do not wear loose clothing or jewelry. They can be caught in moving parts. Rubber gloves and nonskid footwear are recommended when working outdoors. Wear protective hair covering to contain long hair.
9. **USE SAFETY GLASSES.** Also use face or dustmask if operation is dusty.
10. **DON'T ABUSE CORD.** Never carry charger base by cord or yank it to disconnect from receptacle. Keep cord from heat, oil, and sharp edges.
11. **SECURE WORK.** Use clamps or a vise to hold work. It's safer than using your hand and it frees both hands to operate tool.
12. **DON'T OVERREACH.** Keep proper footing and balance at all times.
13. **MAINTAIN TOOLS WITH CARE.** Keep tools sharp and clean for better and safer performance. Follow instructions for lubricating and changing accessories. Keep handles dry, clean and free from oil and grease.
14. **LOCK OFF TOOLS.** When not in use, before servicing, and when changing accessories.
15. **AVOID UNINTENTIONAL STARTING.** Don't carry tool with finger on switch.
16. **STAY ALERT.** Watch what you are doing. Use common sense. Do not operate tool when you are tired.
17. **CHECK DAMAGED PARTS.** Before further use of the tool, a guard or other part that is damaged should be carefully checked to determine that it will operate properly and perform its intended function. Check for alignment of moving parts, binding of moving parts, breakage of parts, mounting, and any other conditions that may affect its operation. A guard or other part that is damaged should be properly repaired or replaced by an authorized service center unless otherwise indicated elsewhere in this instruction manual. Have defective switches replaced by authorized service center. Do not use tool if switch does not turn it on and off.
18. **DO NOT OPERATE** portable electric tools near flammable liquids or in gaseous or explosive atmospheres. Motors in these tools normally spark, and the sparks might ignite fumes.

**CAUTION:** When drilling or driving screws into walls, floors or wherever "live" electrical wires may be encountered, **DO NOT TOUCH ANY FRONT METAL PARTS OF THE TOOL!** Hold the tool only by the plastic handles to prevent electric shock if you drill or drive into a "live" wire.

**NOTE:** The exposed electrical contacts on the tool and the wall mounted charger base are perfectly safe to touch. Touching them is just like handling flashlight batteries.

## SAVE THESE SAFETY RULES FOR FUTURE USE.

taking place. The light will go out when the Screwdriver Plus is removed from the charger base.

### Operation

Although the Screwdriver Plus is really very simple to operate, a few tips on how to use it best are presented here for your information.

### Screw Selection

Of course different applications require different types and sizes of screws. There are literally hundreds of different sizes and shapes of screws and they even come in different materials, but for your purposes, you can generally limit yourself to about two or three sizes and two types.

Round headed wood screws have round heads that stick up above the surface of the wood into which they are driven. In many cases, like hanging applications, this is desirable. In other applications, protruding screw heads are not wanted. Flat headed wood screws are useful here. With the proper countersink and drill bit they can be installed below the surface and covered with putty and painted so as to be invisible. A 1/8" drill bit is supplied with your Screwdriver Plus for pilot hole drilling. Additional drill bits are available at extra cost - see "Accessories" section on page 7 of this manual.

Be careful to avoid overtightening small brass screws. The heads can easily be twisted off and the threads can strip. Hand tightening of these screws is recommended.

We recommend that you use Phillips head screws whenever possible. They are easier to drive because the screwdriver bit will engage more firmly in the screw head.

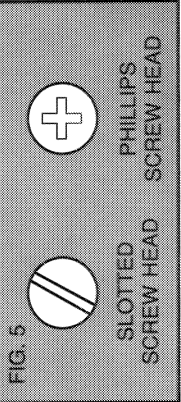

will run. Release the switch and the tool will stop. To operate in reverse (removing fasteners or backing out a jammed drill bit) slide the switch to the left and align it with the arrow pointing backward. **NOTE:** When removing pilot drill bit from work piece, always run tool in reverse. This will help retain the pilot drill bit in the tool spindle.

Depress the switch and the tool will run. Release the switch and the tool will stop. To lock the tool "OFF", slide the switch from either side to the center (no arrow) position.

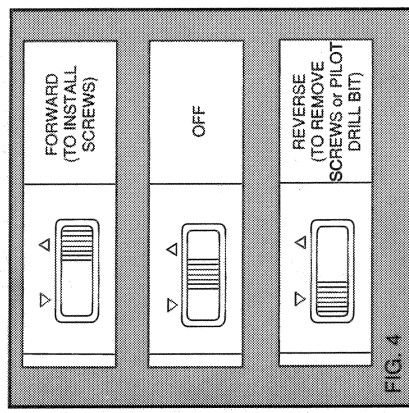

### Charge Indicator Light

(Page 5)

Your Screwdriver Plus is equipped with a Charge Indicator Light which glows whenever the tool is properly on charge. If this light fails to glow when the screwdriver is in the charger base, check the following:

1. Proper insertion of Screwdriver Plus in base.
2. Charger connection to power source.
3. Make sure that charger is not plugged into an outlet that is controlled by a wall switch.
4. Check for blown fuses or tripped circuit breakers.

The light does not indicate the level of charge; it only shows that charging is

## Charger Mounting

### Instructions (Figures 1 & 2)

1. The plastic bag supplied with your tool contains two wood screws and two plastic wall anchors. Use the anchors and screws to mount the charger base to drywall and use the wood screws only to mount it to a wooden surface. (The charger base need not be hung at all to operate properly.)
2. To use the plastic wall anchors drill a 3/16" hole in the drywall where you will be installing the anchor. (Mark the desired place by holding the charger base against the wall and inserting a pencil through one of the two mounting holes.) Don't forget to locate the charger base within 4 feet of a wall outlet. Study figures 1 and 2 carefully. Observe that the bit storage holes are toward the top of the charger base. Failure to mount the base properly will cause the tool to fall out.
3. Insert the plastic wall anchor and tap it lightly with a hammer to seat it flush to the wall. Position the charger base over the anchor and use one of the wood screws to hold the charger base on the wall. Repeat the process for the other mounting hole in the charger base.
4. When mounting the charger base to a wooden surface, drill 3/32" pilot holes for the wood screws. The plastic wall anchors should not be used when hanging the charger base on a wooden wall.

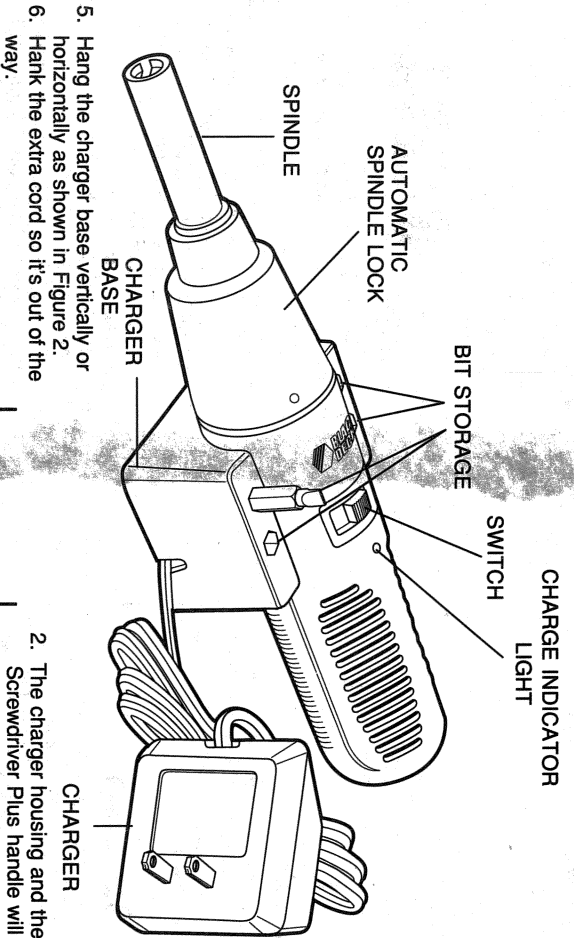
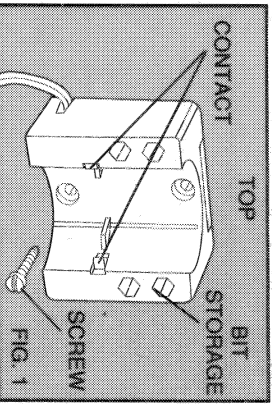

5. Hang the charger base vertically or horizontally as shown in Figure 2.
6. Hank the extra cord so it's out of the way.

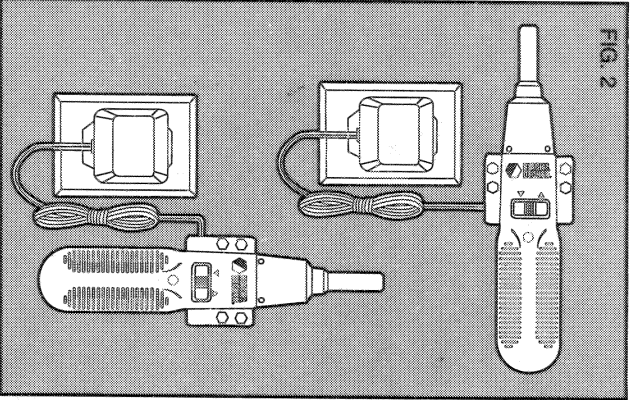

### Charging Notes

**NOTE:** The Screwdriver Plus was sent from the factory in an uncharged condition. Before attempting to use it, it must be charged for 12 hours.

1. **DO NOT PLACE** the charger base in an area of extreme heat or cold... it will work best at normal room temperature.

tive nature such as, but not limited to, steel wool, aluminum foil, or any buildup of metallic particles should be kept away from charging contacts. Unplug charger before attempting to clean.

### Bit Storage

The screwdriver bit supplied with your Screwdriver Plus is a double ended type with a No. 2 Phillips on one end and a No. 8-10 flat blade on the other. The bit can be stored in the Screwdriver Plus or in one of the holes in the charger base as shown in the large figure above. Note that there are four holes in the charger base to accommodate the screwdriver bit, the 1/8" drill bit and the 5/16" nut running bit.

### Automatic Spindle Lock

Your Screwdriver Plus is equipped with an Automatic Spindle Lock feature that locks the spindle in place whenever the switch button (Fig. 4) is released.

When the spindle is locked, operate the tool as you would any conventional (non-powered) screwdriver.

### Bit Insertion (Figure 3)

There is a spring retainer inside the tool's spindle that prevents bits from falling out. Simply insert the desired bit as far as it will go. There's nothing to tighten, nothing to loosen. When finished, you can easily pull the bit out or store the tool with the bit in it.

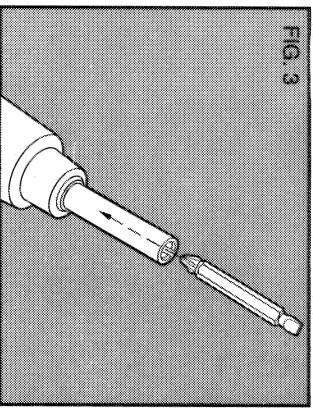

### Switch (Figure 4)

To turn the Screwdriver Plus "ON" in a forward (driving fasteners or drilling holes) position, slide the switch to the right and align it with the arrow pointing forward. Depress the switch and the tool